

Corner unit weight  
80kg.

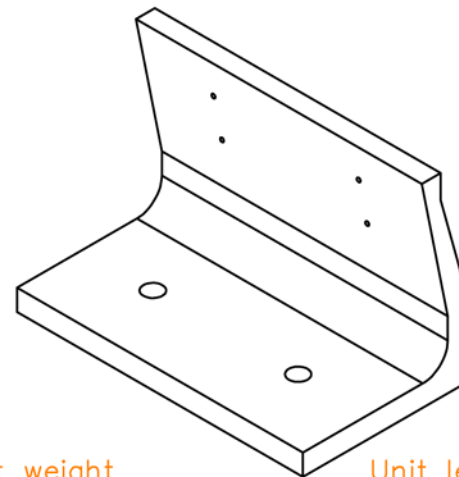
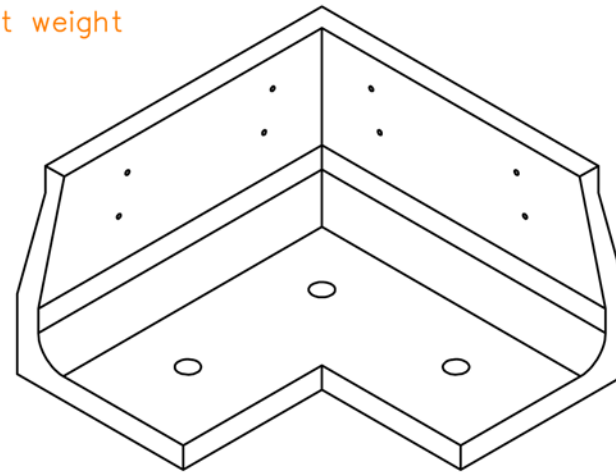

610mm unit weight  
43kg

Unit length 610mm